

Sistem complet de sortare 8001 | KM-MV-4-8001

Sistem de selectie mobil

Permite tratarea bovinelor cu blandete si fara raniri.

- Un instrument esential pentru marcarea, numararea, clasificarea, tratamentul sanitar si veterinar al animalelor.
- Un avantaj suplimentar este ca raspunde nevoilor epocii noastre in ceea ce priveste siguranta muncii, deoarece circumstantele predominante in zona de lucru sunt pe deplin reglementate si controlate in timpul tratamentelor, pentru siguranta animalelor si a oamenilor.
- Proiectarea si implementarea produselor tehnologice de crestere a bovinelor/sistemelor de sortare se realizeaza si pe baza nevoilor individuale! Il vizezi, noi il proiectam si il producem! Daca este necesar, intreprindem si un sondaj la fata locului pentru a crea cele mai precise planuri in software-ul nostru CAD de modelare 3D!
- Design galvanizat la cald.

Componentele produselor noastre pot fi achizitionate separat. Consultati oferta pe site-ul nostru! crestereabovinelor.ro | kismet.ro



Consultati oferta pe site-ul nostru!
crestereabovinelor.ro

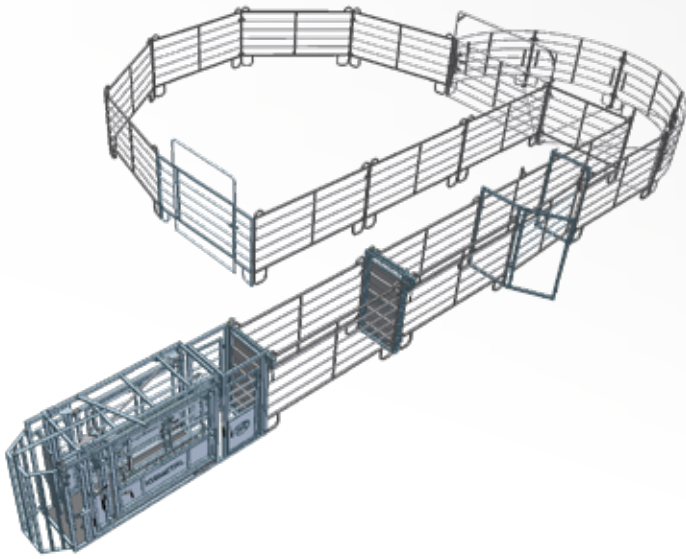

Sistem complet de sortare 8001 | KM-MV-4-8001

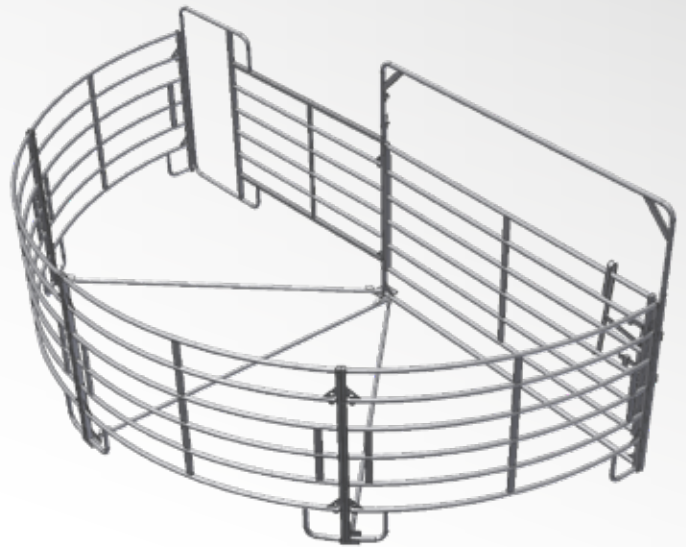

Set de dirijare cu 4 panouri curbate | KM-MV-4-8104

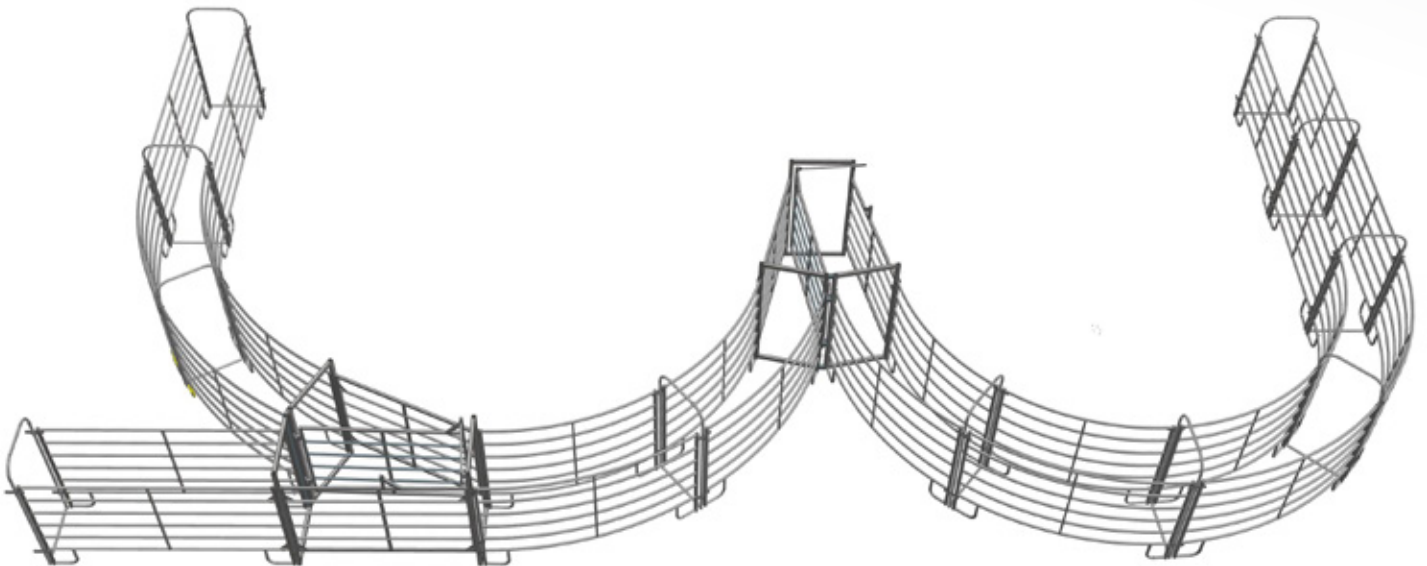

Sistem de sortare cu 3 cai | KM-MV-4-8106

KM-MV-4-8001	Sistem complet de sortare 8001
KM-MV-4-8002	Sistem complet de sortare 8002
KM-MV-4-8003	Sistem complet de sortare 8003
KM-MV-4-8102	Set de dirijare cu 2 panouri curbate
KM-MV-4-8104	Set de dirijare cu 4 panouri curbate
KM-MV-4-8106	Sistem de sortare cu 3 cai



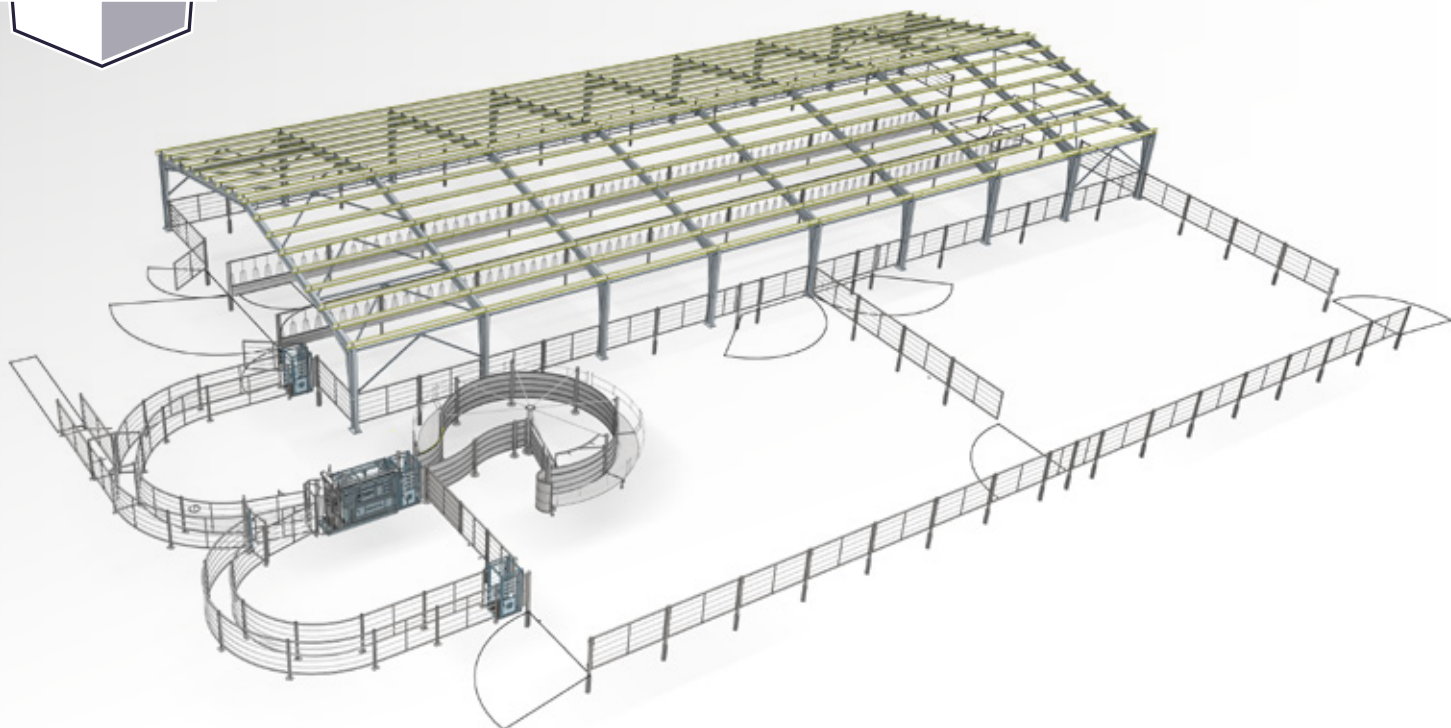

Cladire hambar deschis cu sistem de selectie
20 m x 48 m x 4 m | Locul constructiei: **Pusztaföldvár**

Design individual

Proiectarea si implementarea produselor tehnologice de crestere a bovinelor/sistemelor de sortare se realizeaza pe baza nevoilor individuale!

- Il vizezi, noi il proiectam si il producem.
- Daca este necesar, intreprindem si un sondaj la fata locului pentru a crea cele mai precise planuri in software-ul nostru CAD de modelare 3D!

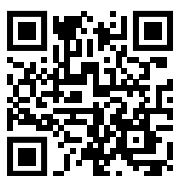

Consultati oferta pe site-ul nostru!
crestereabovinelor.ro



Sistem de tarcuri instalatie fixa (design si implementare)
50 m x 85 m | Locul constructiei: Kiskőrös

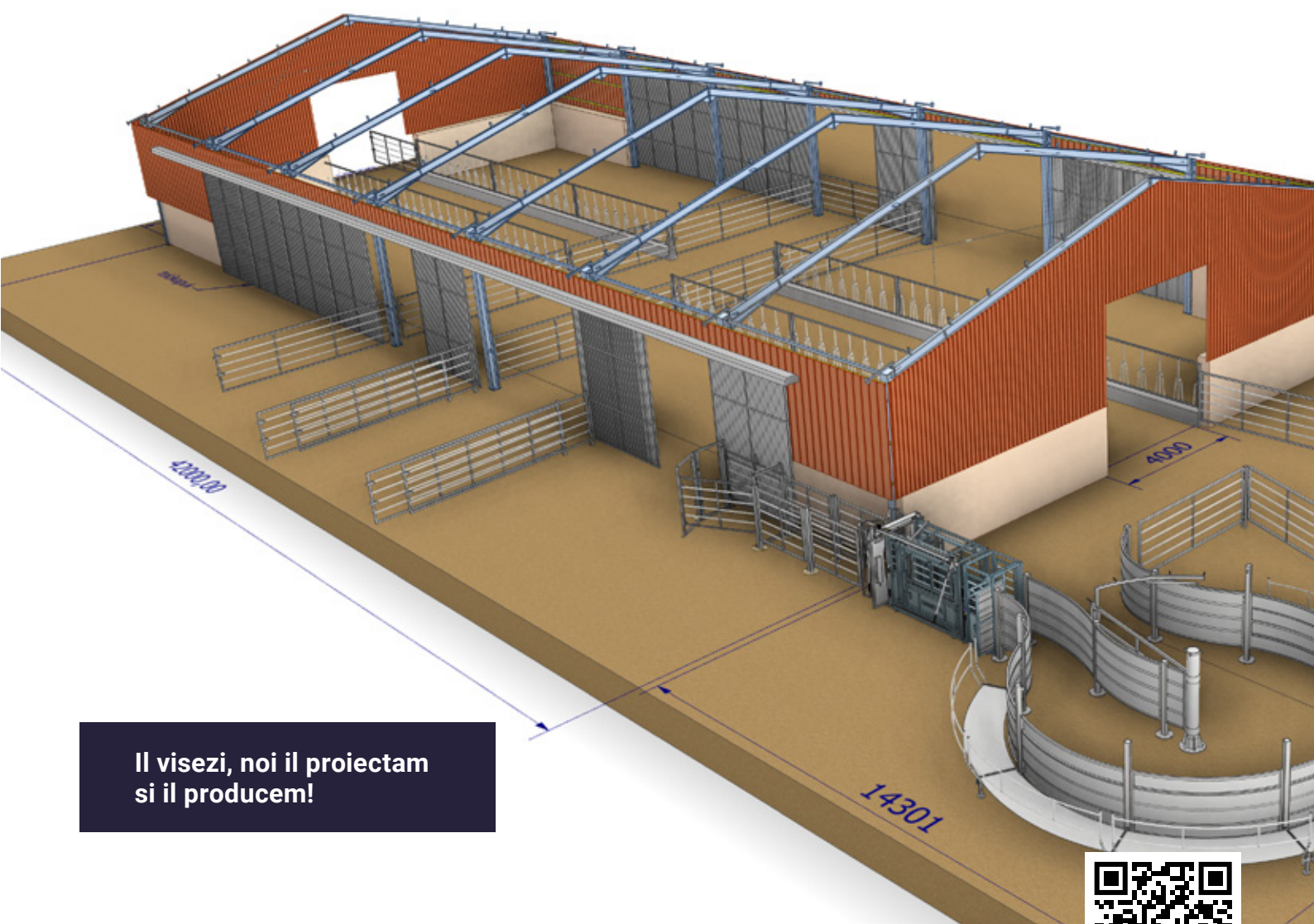

**Il visezi, noi il proiectam
si il producem!**

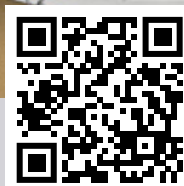



Stand universal pentru bovine, cu jug si poarta de prindere, intrare din spate si sas 6-04 (galvanizat la cald)
KM-MV-6-04-H

Standuri de contentie pentru tratamente

Asigura fixarea animalului la capatul aleii de lucru, are cate 2 usi pe fiecare parte care permit accesul la diverse tratamente. Este combinat cu o grila frontala, care ar putea fi deschisa si inchisa, pentru a preveni iesirea si ranirea animalului.

- Dimensiunea jugului este reglabila, astfel incat poate fi utilizata la majoritatea grupelor de varsta.
- Oferta noastra include si produsele austriece Rosensteiner GmbH.
- Dispozitiv de fixare rapid, sigur, fara accidente.
- Design galvanizat la cald.

Stand de contentie tratamente, optional se pot instala elemente aditionale pentru facilitarea tratamentelor la animale.

ROSENSTEINER
perfekt einfach.



Consultati oferta pe site-ul nostru!
crestereabovinelor.ro

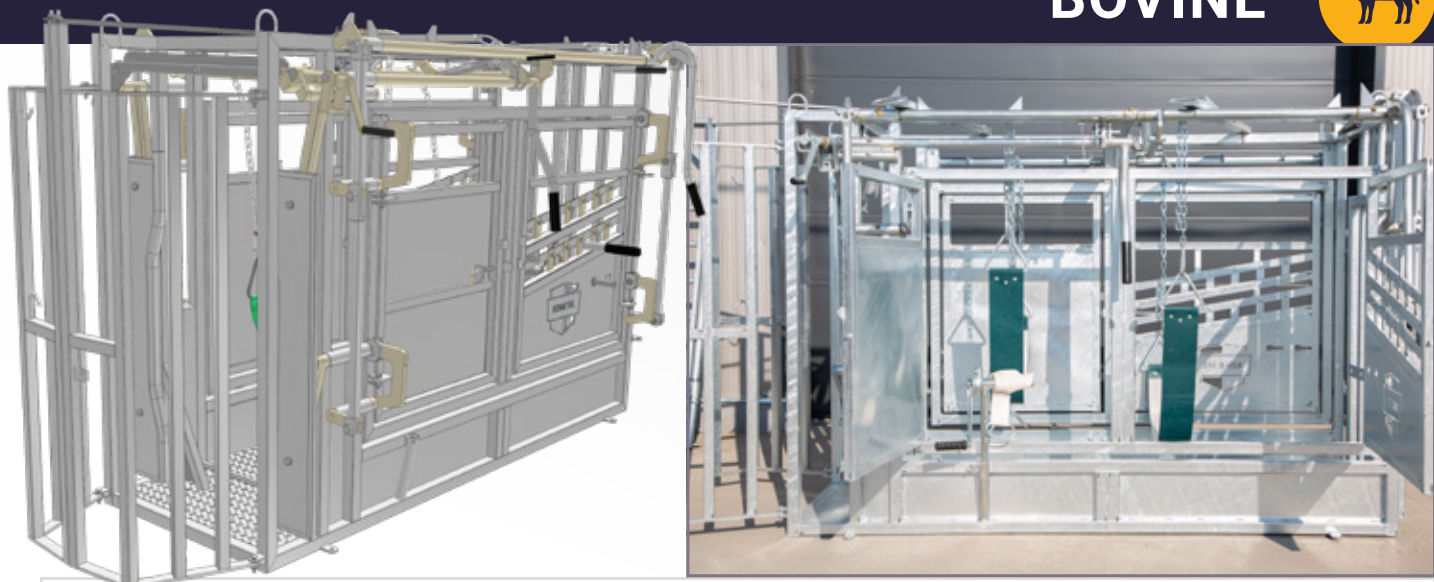

Seria KM-MV-4 standuri pentru tratament

KM-MV-4-04-H	Stand de contentie cu jug, pentru bovine 4-04 (galvanizat la cald)
KM-MV-4-05-H	Stand de contentie cu jug, pentru bovine, varianta cu chingi de ridicare pentru ingrijire oncloane 4-05 (galvanizat la cald)
KM-MV-4-06-H	Stand universal de contenție cu jug, pentru bovine cu posibilitate de reglare a peretilor 4-06 (galvanizat la cald)
KM-MV-4-07-H	Stand de contentie universal cu jug, pentru bovine, varianta cu chingi de ridicare (Pereti laterali mobili) (galvanizat la cald)

Seria KM-MV-5 standuri pentru tratament

KM-MV-5-01-H	Stand universal de contentie pentru bovine, cu jug si ușa glisanta 5-01 (galvanizat la cald)
KM-MV-5-02-H	Stand universal de contentie pentru bovine, cu jug, usa glisanta si sas pentru tratamente 5-02 (galvanizat la cald)

Seria KM-MV-6 standuri pentru tratament

KM-MV-6-02-H	Stand universal pentru bovine, cu cauciuc/jug cu poarta si sas 6-02 (galvanizat la cald)
KM-MV-6-04-H	Stand universal pentru bovine, cu jug si poarta de prindere, intrare din spate si sas 6-04 (galvanizat la cald)
KM-MV-6-02-H-WHC	Stand universal de contentie pentru bovine, cu jug si usa stavilar, varianta cu chingi de ridicare (Pereti laterali mobili) (galvanizat la cald)
KM-MV-6-04-H-WHC	Stand universal de contentie pentru bovine, cu jug, sas si usa stavilar in spate, varianta cu chingi de ridicare (Pereti laterali mobili) (galvanizat la cald)

Rosensteiner standuri pentru tratament

KM-ROSEN-VETPRO	Rosensteiner Vet Pro tratament universal pentru operatiile veterinare
KM-ROSEN-BULLTS	Rosensteiner Bull Top S ingrijirea oncloanelor si tratamente bovine
KM-ROSEN-BULLTM	Rosensteiner Bull Top M ingrijirea oncloanelor si tratamente bovine





Jug pentru bovine cu poarta frontala
(galvanizat la cald) | KM-MV-4-02-H



Jug pentru bovine glisant
(galvanizat la cald - galvanizat) | KM-MV-6-01-H

Juguri cu poarta

Dimensiunea jugului cu poarta este reglabila, astfel incat poate fi utilizat cu majoritatea grupelor de varsta. Jugul cu poarta este combinat cu o grila frontala, care ar putea fi deschisa si inchisa, pentru a preveni iesirea animalului sau ranirea acestuia.

- Dispozitiv de fixare rapid, sigur, fara accidente. In cazul bovinelor cu coarne lungi, putem livra jugul cu grila frontala mai mare.
- Design galvanizat la cald.

KM-MV-4-02-H	Jug pentru bovine cu poarta frontala (galvanizat la cald)
KM-MV-6-01-H	Jug pentru bovine cu poarta frontala (galvanizat la cald - galvanizat)
KM-MV-6-01WG-H	Jug pentru bovine cu poarta cu grila frontala (galvanizat la cald - galvanizat)
KM-INSZ-4-01-H	Jug de prindere cu poarta mobila si panou de selectie lateral (galvanizat la cald)

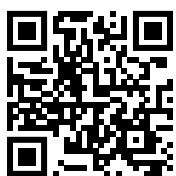



ROSENSTEINER
perfekt einfach.

Stand pentru intretinerea ongoanelor bovine
Rosensteiner Red 5 - Profesional | KM-ROSEN-RED5P

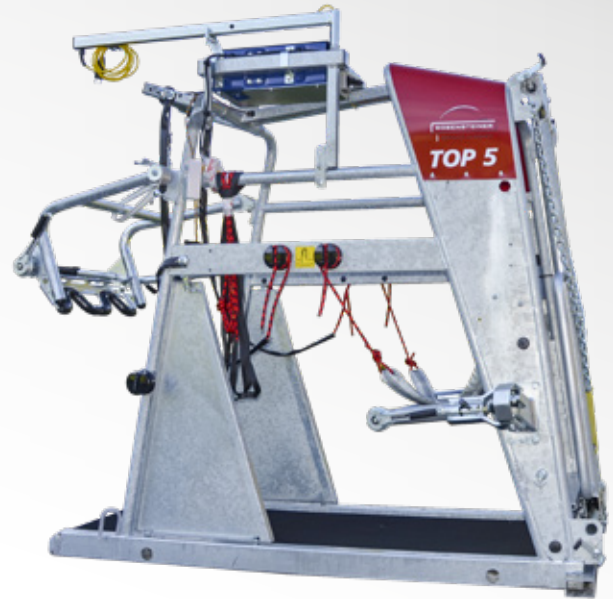

Top 5 Rosensteiner pentru intretinerea ongoanelor bovine -
Profesional | KM-ROSEN-TOP5P

Standuri pentru intretinerea ongoanelor

Standuri de contentie pentru nevoi personale si intretinerea ongoanelor.

- Produsele companiei austriece Rosensteiner GmbH ofera o solutie pentru profesionistii in ingrijirea ongoanelor efectivelor de bovine mici, medii si mari!
- Design galvanizat la cald si acoperit cu pulbere.

Rosensteiner Bull Top seria	
KM-ROSEN-BULLTS	Rosensteiner Bull Top S pentru tratament si intretinerea ongoanelor bovinelor
KM-ROSEN-BULLTM	Rosensteiner Bull Top M pentru tratament si intretinerea ongoanelor bovinelor
Rosensteiner Red Q	
KM-ROSEN-REDQ	Rosensteiner Red Q pentru intretinerea ongoanelor bovinelor
Rosensteiner Kipp Top seria	
KM-ROSEN-KT2B	Rosensteiner Kipp Top II pentru intretinerea ongoanelor bovinelor - Basic
KM-ROSEN-KT2C	Rosensteiner Kipp Top II pentru intretinerea ongoanelor bovinelor - Comfort
KM-ROSEN-KT2P	Stand pentru intretinerea ongoanelor bovine Rosensteiner Kipp Top II - Professional
Rosensteiner RS-Q seria	
KM-ROSEN-RSQ	Stand SPECIAL pentru intretinerea ongoanelor bovine Rosensteiner RS-Q

Majoritatea produselor sunt disponibile in versiune trailer

Rosensteiner Top 5 seria	
KM-ROSEN-TOP5B	Top 5 Rosensteiner pentru intretinerea ongoanelor bovine - Basic
KM-ROSEN-TOP5C	Top 5 Rosensteiner pentru intretinerea ongoanelor bovine - Comfort
KM-ROSEN-TOP5P	Top 5 Rosensteiner pentru intretinerea ongoanelor bovine - Professional
Rosensteiner Red 5 seria	
KM-ROSEN-RED5B	Stand pentru intretinerea ongoanelor bovine Rosensteiner Red 5 - Basic
KM-ROSEN-RED5C	Stand pentru intretinerea ongoanelor bovine Rosensteine Red 5 - Comfort
KM-ROSEN-RED5P	Stand pentru intretinerea ongoanelor bovine Rosensteiner Red 5 - Professional

Consultati oferta pe site-ul nostru!
kismet.ro



Sasie de cantarire, structuri de cantarire

Standuri de cantarire si sasiuri de cantarire, care indeplinesc complet cerintele cantaririi bovinelor.

- Un mare avantaj al sasiurilor de cantarire este ca pot functiona independent.
- Produsele sunt disponibile ca dispozitive separate, respectiv ca structuri integrate.
- Design galvanizat la cald.



Sasiu de cantarire + structura de stand pentru cantarire cu 2 porti de intrare-iesire (galvanizat la cald)
KM-MG-4-04-H

Sasie de cantarire	
KM-MG-4-01-H	Sasiu de cantarire galvanizat la cald 01
KM-MG-4-02-H	Sasiu de cantarire galvanizat la cald 02
Standuri de cantarire	
KM-MG-4-03-H	Stand pentru cantarire bovine (galvanizat la cald)
Structuri de cantarire	
KM-MG-4-04-H	Sasiu de cantarire + structura de stand pentru cantarire cu 2 porti de intrare-iesire (galvanizat la cald)

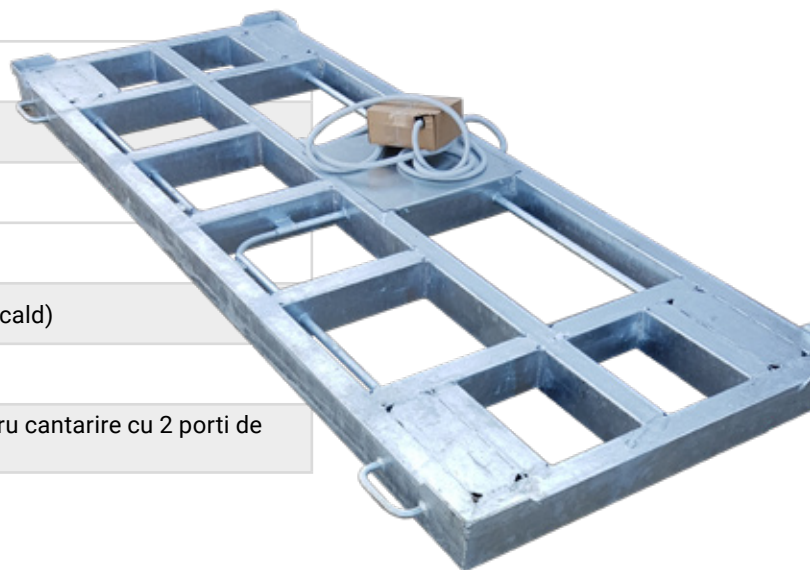



Cresa de vitei cu 15 locuri si acoperis
(galvanizat la cald) | KM-MB-GWR015

Crese de vitei

Cresele de vitei asigura furajarea viteilor
in asa fel incat animalele adulte sa nu aiba acces la ele.

- Latimea trapelor de pe elementul lateral poate fi reglata.
- Distanța orificiului de admisie a rezervorului este reglabila.
- Padocul poate fi modificat cu un singur surub astfel asigurand o manipulare economica si usoara din punct de vedere al spatiului necesar. Cresa poate fi tractata.
- Design galvanizat la cald.
- Produsele GWR pot fi extinse cu pana la 15 locuri!

Cresa de vitei cu 30 de locuri si
acoperis (galvanizat la cald)
KM-MB-GWR030

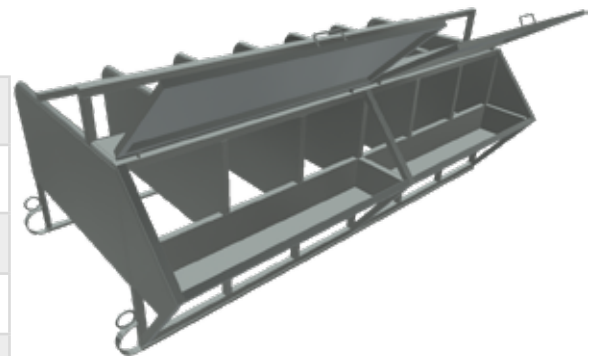

Cresa de vitei cu boxe pentru 6 vitei
(galvanizat la cald) | KM-MB-BOX06-H



KM-MB-TWN01-H	Cresa de vitei cu posibilitatea hranirii pe una din laturi (galvanizat la cald)
KM-MB-TWN02-H	Cresa duplex pentru vitei cu posibilitate de hranire pe 2 laterale (galvanizat la cald)
KM-MB-BOX06-H	Cresa de vitei cu boxe pentru 6 vitei (galvanizat la cald)
KM-MB-BOX08-H	Cresa de vitei cu boxe pentru 8 vitei (galvanizat la cald)
KM-MB-BOX10-H	Cresa de vitei cu boxe pentru 10 vitei (galvanizat la cald)
KM-MB-GWR015	Cresa de vitei cu 15 locuri si acoperis (galvanizat la cald)
KM-MB-GWR030	Cresa de vitei cu 30 de locuri si acoperis (galvanizat la cald)



Cresa duplex pentru vitei cu posibilitate de hranire pe 2 laterale
(galvanizat la cald) | KM-MB-TWN02-H

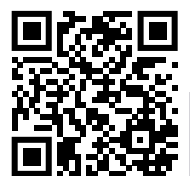



Remorca pentru furajarea bovinelor, cu 24 de locuri (galvanizat la cald) | KM-MEV15-24WT



Iesle pentru bovine, cu 24 de locuri, talpa de sanie, lungimea 6 m (galvanizat la cald) | KM-MEV15-24WTWR

Jgheaburi de hranire si adapare

Jgheaburi pentru hranire si adapatoare, fabricate in mai multe modele, in functie de nevoile individuale.

- Design galvanizat la cald.

Jgheaburi de hranire	Jgheaburi concepute exclusiv pentru hranire remorcabile sau cu suport tip sanie, pentru tractare.
KM-MEV15 seria	De asemenea ieslele pot fi comandate si cu acoperis!
Jgheaburi de adapare	Jgheaburi urias pe baza de sanie
KM-MIV1515 seria	Latimea jgheabului: 1500 mm. Insertia de jgheab este laminata din tabla de 1,5 mm. Lungimi disponibile: 4; 5; 6 m.
KM-MIV1520 seria	Latimea jgheabului: 1500 mm. Insertia de jgheab este laminata din tabla de 2 mm. Lungimi disponibile: 4; 5; 6 m.
KM-MIV1530 seria	Latimea jgheabului: 1500 mm. Insertia de jgheab este laminata din tabla de 3 mm. Lungime disponibila: 6 m.
Jgheaburi de hranire si adapare	Produsele pot fi comandate cu picioare de placa, picioare de sprijin si baza de sanie
KM-MIV615 seria	Latimea jgheabului: 690 mm. Insertia de jgheab este laminata din tabla de 1,5 mm. Lungimi disponibile: 2; 3; 4; 5; 6 m.
KM-MIV620 seria	Latimea jgheabului: 690 mm. Insertia de jgheab este laminata din tabla de 2 mm. Lungimi disponibile: 2; 3; 4; 5; 6 m.
KM-MIVM6 seria (rotund)	Latimea jgheabului: 690 mm. Insertia de jgheab este laminata din tabla de 2 mm. Lungimi disponibile: 1,25; 2; 4; 5; 6 m.
KM-MIV9 seria (lat, rotund)	Latimea jgheabului: 990 mm. Insertia de jgheab este laminata din tabla de 2 mm. Lungimi disponibile: 4; 6 m.

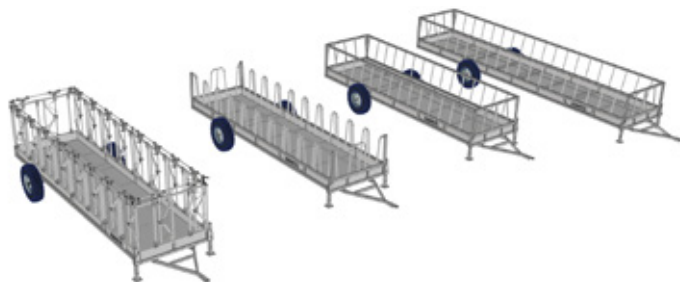

Jgheab de adapare urias pentru bovine, cu talpa de sanie galvanizata din profil inchis | KM-MIV1520-4-H

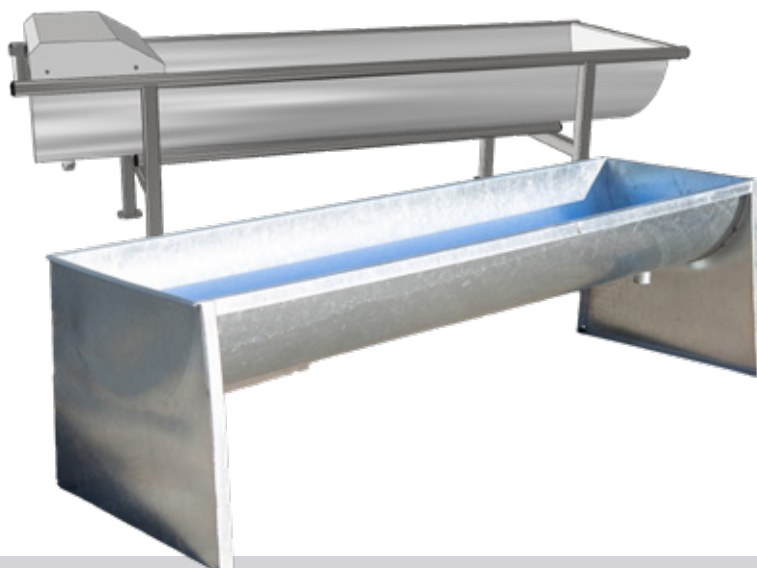

Vizitati site-ul nostru web pentru mai multe informatii!
crestereabovinelor.ro



Jgheab de adapare si hranire, pentru bovine, cu talpa galvanizata din profil inchis, lungimea = 6 m | KM-MIV620-6-H



Remorca pentru furajarea bovinelor (galvanizat la cald)
KM-MEV15-20WT-RAILAUT-01



Jgheaburi de hranire urias, pe baza tip sanie
(galvanizat la cald) | KM-MEV15-20



Remorca pentru furajarea bovinelor, cu 24 de locuri, cu acoperis (galvanizat la cald) | KM-MEV15-24WTWR





lesle pentru furajare cu 12 locuri de hranire si acoperis
ANG01 | KM-ME-4-12ANG01



lesle pentru furajare cu 12 locuri de hranire si acoperis
ANG02 | KM-ME-4-12ANG02

lesle rotunde pentru baloti

Din punct de vedere economic, este important sa nu risipim materiale de calitate.

- leslele de furajare protejeaza balotul de murdarie si pierdere prin calcare.
- Design galvanizat la cald.



lesle pentru baloti rotunzi cu 12 locuri de hranire si acoperis, intarit | KM-ME-4-12RIWR

KM-ME-4-12	lesle pentru baloti rotunzi cu 12 locuri de hranire
KM-ME-4-12RI	lesle pentru baloti rotunzi cu 12 locuri de hranire, intarita
KM-ME-4-12WR	lesle pentru baloti rotunzi cu 12 locuri de hranire si acoperis
KM-ME-4-12RIWR	lesle pentru baloti rotunzi cu 12 locuri de hranire si acoperis, intarit
KM-ME-4-12WFC	lesle pentru baloti rotunzi cu 12 locuri de hranire, acoperita complet cu foi de metal
KM-ME-4-12RIWFC	lesle pentru baloti rotunzi cu 12 locuri de hranire, intarita, acoperita complet cu foi de metal
KM-ME-4-16	lesle pentru baloti rotunzi cu 16 locuri de hranire
KM-ME-4-16RI	lesle pentru baloti rotunzi cu 16 locuri de hranire, intarita
KM-ME-4-16RIWFC	lesle pentru baloti rotunzi cu 16 locuri de hranire, intarita, acoperita complet cu foi de metal
KM-ME-4-12ANG01	lesle pentru furajare cu 12 locuri de hranire si acoperis ANG01
KM-ME-4-12ANG02	lesle pentru furajare cu 12 locuri de hranire si acoperis ANG02
KM-ME-4-12ANG03	lesle pentru furajare cu 12 locuri de hranire si acoperis ANG03



Vizitati site-ul nostru web pentru mai multe informatii!
crestereabovinelor.ro



Front de furajare bovine cu blocare automata tip 02HL | KM-ME-4-RAIL02HL

Front de furajare autoblocant pentru bovine tip 03HL
KM-ME-4-RAIL03HL

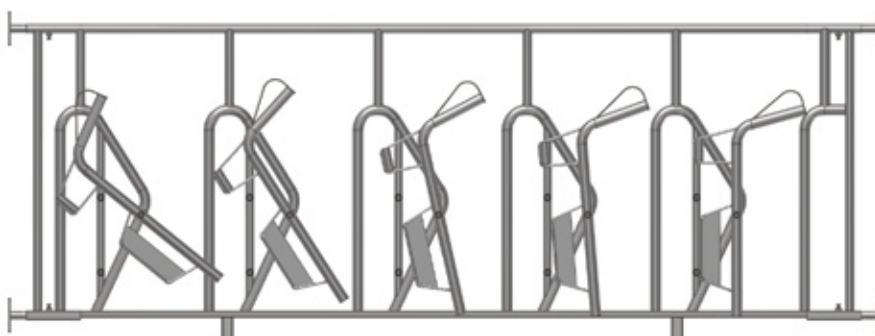

Fronturi de furajare

Fronturi de furajare, realizate exclusiv la comanda in functie de nevoile individuale.

- In functie de tip fabricam produsele conform cerintelor dumneavaostra.
- Design galvanizat la cald.

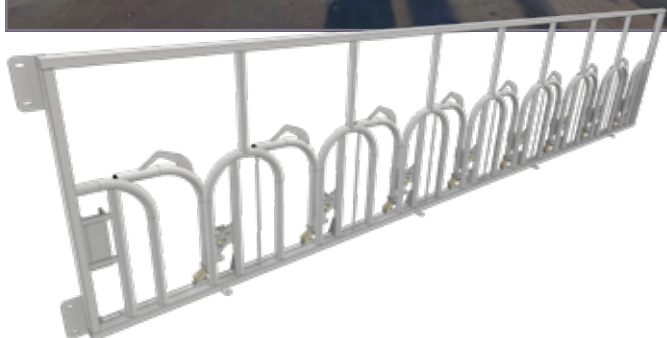

KM-ME-4-RAILN	Front de furajare bovine (loc de hranire)
KM-ME-4-RAILRI	Front de furajare ranforsat bovine (loc de hranire)
KM-ME-4-RAILSK	Front de furajare bovine cu grila diagonala (metru)
KM-ME-4-RAILSKADJ	Front de furajare bovine cu grila diagonala reglabila (metru)
KM-ME-4-RAIL01HL	Front de furajare bovine cu blocare automata tip 01HL (loc de hranire)
KM-ME-4-RAIL02HL	Front de furajare bovine cu blocare automata tip 02HL (loc de hranire)
KM-ME-4-RAIL03HL	Front de furajare autoblocant pentru bovine tip 03HL (loc de hranire)





Adapatoare dubla cu bile, anti-inghet, Erinox 110 I | KM-MI-ERXD110

Adapatoare

Adapatoare anti inghet Erinox.

- Previne apa sa inghete pana la minus 28 Celsius.
- Versiuni de 40 si 110 litri.
- In functie de produs, este potrivit pentru satisfacerea necesarului de apa a 15-40 de animale.
- Suportul poate fi cumparat in varianta galvanizata.

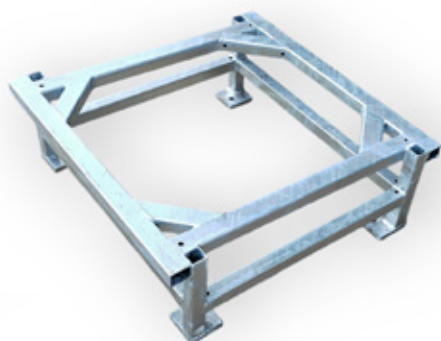

Suport pentru adapatoare Erinox
KM-MIT-ERXD40

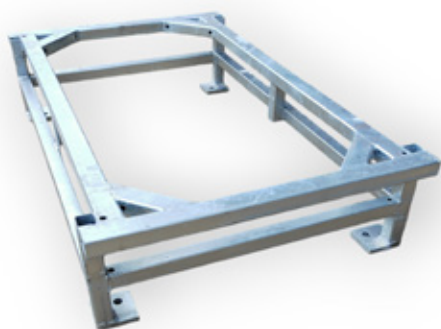

Suport pentru adapatoare dubla Erinox
KM-MIT-ERXD110



Adapatoare anti-inghet, Erinox 40 I
KM-MI-ERXD40

KM-MI-ERXD40	Adapatoare anti-inghet, Erinox 40 I
KM-MI-ERXD110	Adapatoare dubla cu bile, anti-inghet, Erinox 110 I.
KM-MIT-ERXD40	Suport pentru adapatoare Erinox
KM-MIT-ERXD110	Suport pentru adapatoare dubla Erinox





Rampe pentru animale

Rampe pentru animale de dimensiuni standard care pot fi tractate, deplasate manual pentru un transport in siguranta.

- Design galvanizat la cald.



Rampa pentru cresterea animalelor cu inaltime reglabila (galvanizat la cald)
KM-MF-4-04-H



Rampe pentru animale, cu inaltime fixa a rampei (galvanizat la cald)
KM-MF-4-03-H



Rampa pentru animale cu inaltime reglabila, culoar lateral (galvanizat la cald) | KM-MF-4-04R-H

KM-MF-4-03-H	Rampe pentru animale, cu inaltime fixa a rampei (galvanizat la cald)
KM-MF-4-04-H	Rampa pentru cresterea animalelor cu inaltime reglabila (galvanizat la cald)
KM-MF-4-04R-H	Rampa pentru animale cu inaltime reglabila, culoar lateral (galvanizat la cald)





Display auxiliar DGT100 (100 mm inaltime, design IP68)
KM-MG-DGT100



Afisaj de cantarire DFWLKI
KM-MG-DFWLKI



Afisaj de cantarire Carcasa din plastic DFWLB
KM-MG-DFWLB



Afisaj de cantarire 3590EGTCXT01BC
KM-MG-3590EGTCXT01BC

Display cantar

Oferim clientilor nostri o gama larga de afisaje si accesorii de cantarire, special concepute pentru cresterea bovinelor si a ovinelor.

- Afisaj digital de cantarire cu ecran mare



Display auxiliar DGT60 (60 mm inaltime)
KM-MG-DGT60

KM-MG-DFWLB	Afisaj de cantarire carcasa din plastic DFWLB (ABS cu protectie IP68.)
KM-MG-DFWLI	Afisaj de cantarire DFWLI (5 butoane, carcasa din inox cu protectie IP68.)
KM-MG-DFWLKI	Afisaj de cantarire DFWLKI (17 butoane, carcasa din inox cu protectie IP68.)
KM-MG-DFWLID-1	Afisaj de cantarire DFWLID (Carcasa din inox cu protectie IP68, 5 butoane, LCD.)
KM-MG-DFWLID-3	Afisaj de cantarire DFWLID (Carcasa din inox cu protectie IP68, 5 butoane, LCD, baterie incorporata.)
KM-MG-3590EXP	Afisaj de cantarire 3590EXP (Carcasa din plastic ABS cu protectie IP65, tastatura impermeabila cu 25 de butoane.)
KM-MG-3590EXT	Afisaj de cantarire 3590EXT (Carcasa din inox cu protectie IP68, tastatura rezistenta la apa cu 25 de butoane.)
KM-MG-3590EGTXT01BC	Afisaj de cantarire 3590EGTXT01BC (Carcasa din inox cu protectie IP68, ecran tactil LCD grafic.)
KM-MG-3590EGTCXT01BC	Afisaj de cantarire 3590EGTCXT01BC (Carcasa din inox cu protectie IP68, ecran tactil LCD grafic color.)
KM-MG-DGT60	Display auxiliar DGT60 (60 mm inaltime)
KM-MG-DGT100	Display auxiliar DGT100 (100 mm inaltime, design IP68)



Vizitati site-ul nostru web pentru mai multe informatii!
crestereabovinelor.ro



Supapa plutitoare pentru jgheaburi si rezervoare de apa (3/4 inch) + carcasa placa | KM-MIVM6-USZJ34



Supapa plutitor cu flotor mare + carcasa placa KM-MIV6-USZNU

Valve

Oferta noastra include, de asemenea, o gama larga de robinete /supape cu flotor si cutii metal de protectie pentru jgheaburile noastre.



Supapa cu plutitor cu debit foarte mare + carcasa cu placa | KM-MIVM6-USZXTRA

KM-MIVM6-USZJ12	Supapa plutitoare pentru jgheaburi si rezervoare de apa (1/2 inch) + carcasa placa
KM-MIVM6-USZJ34	Supapa plutitoare pentru jgheaburi si rezervoare de apa (3/4 inch) + carcasa placa
KM-MIVM6-USZNU	Supapa plutitor cu flotor mare + carcasa placa
KM-MIVM6-USZXTRA	Supapa cu plutitor cu debit foarte mare + carcasa cu placa

Pretul supapelor, ca articole optionale, se poate modifica in functie de spatiul necesar instalarii (latimea jgheabului).



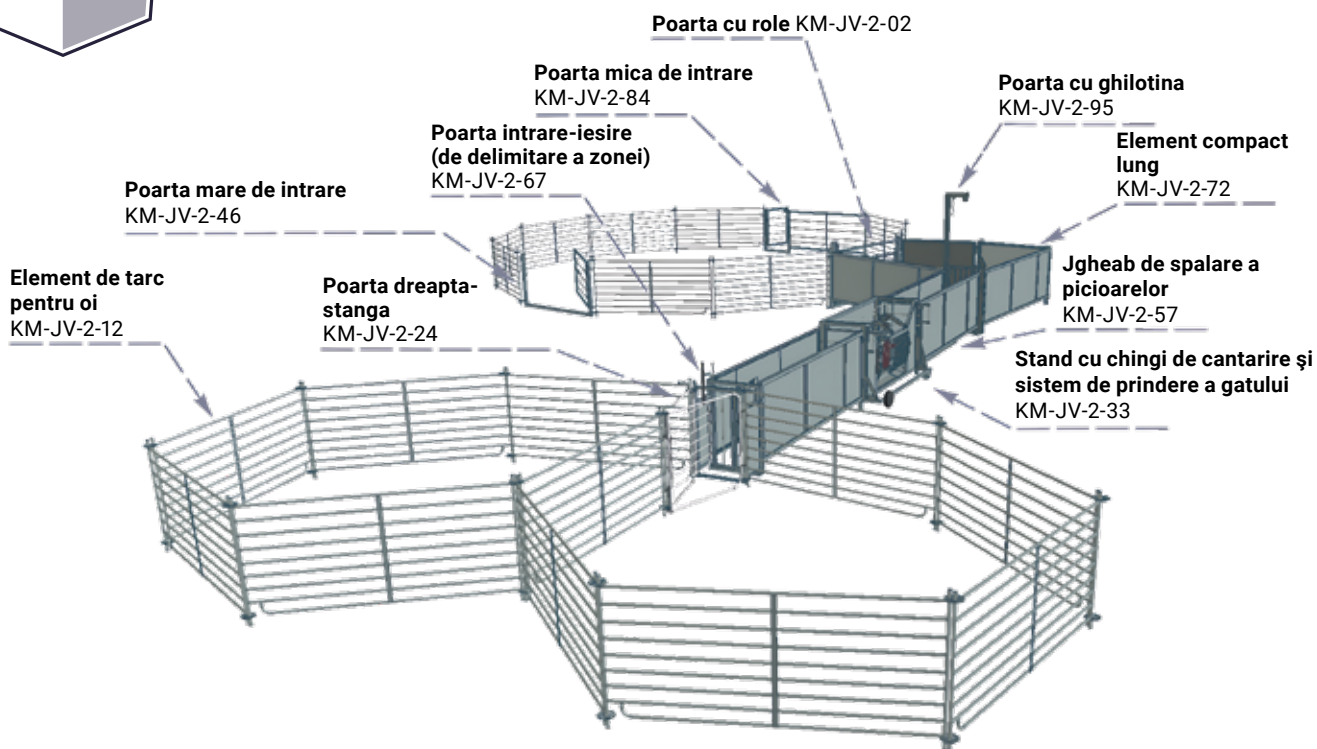

Sistem de sortare ovine 0001 | KM-JV-2-0001

Sistem de corali

Sistemul de sortare are o mare importanta in tratarea individuala a oilor, atat in ceea ce priveste vaccinarea, cat si numerotarea sau marcarea.

- Proiectare si implementare de produse tehnologice de crestere a oilor si sisteme de sortare pe baza nevoilor individuale! Il vizezi, il proiectam si il producem! Daca este necesar, intreprindem si un sondaj la fata locului pentru a crea cele mai precise planuri in software-ul nostru CAD de modelare 3D!
- Design galvanizat la cald.

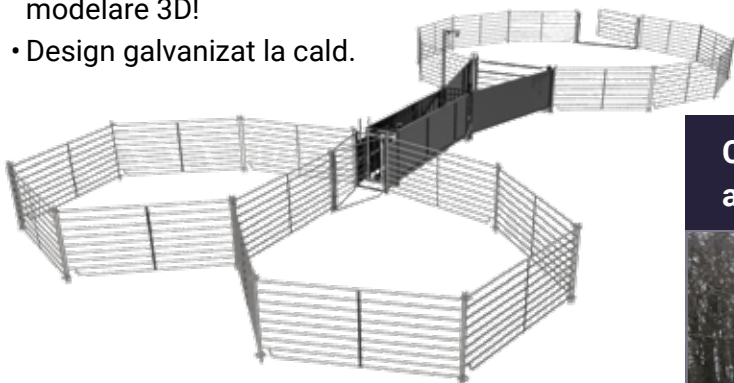

Componentele produselor noastre pot fi achizitionate separat.



Sistem de sortare ovine 0002 | KM-JV-2-0002

KM-JV-2-0001 Sistem de sortare ovine 0001

KM-JV-2-0002 Sistem de sortare ovine 0002



Vizitati site-ul nostru web pentru mai multe informatii!
kismet.ro

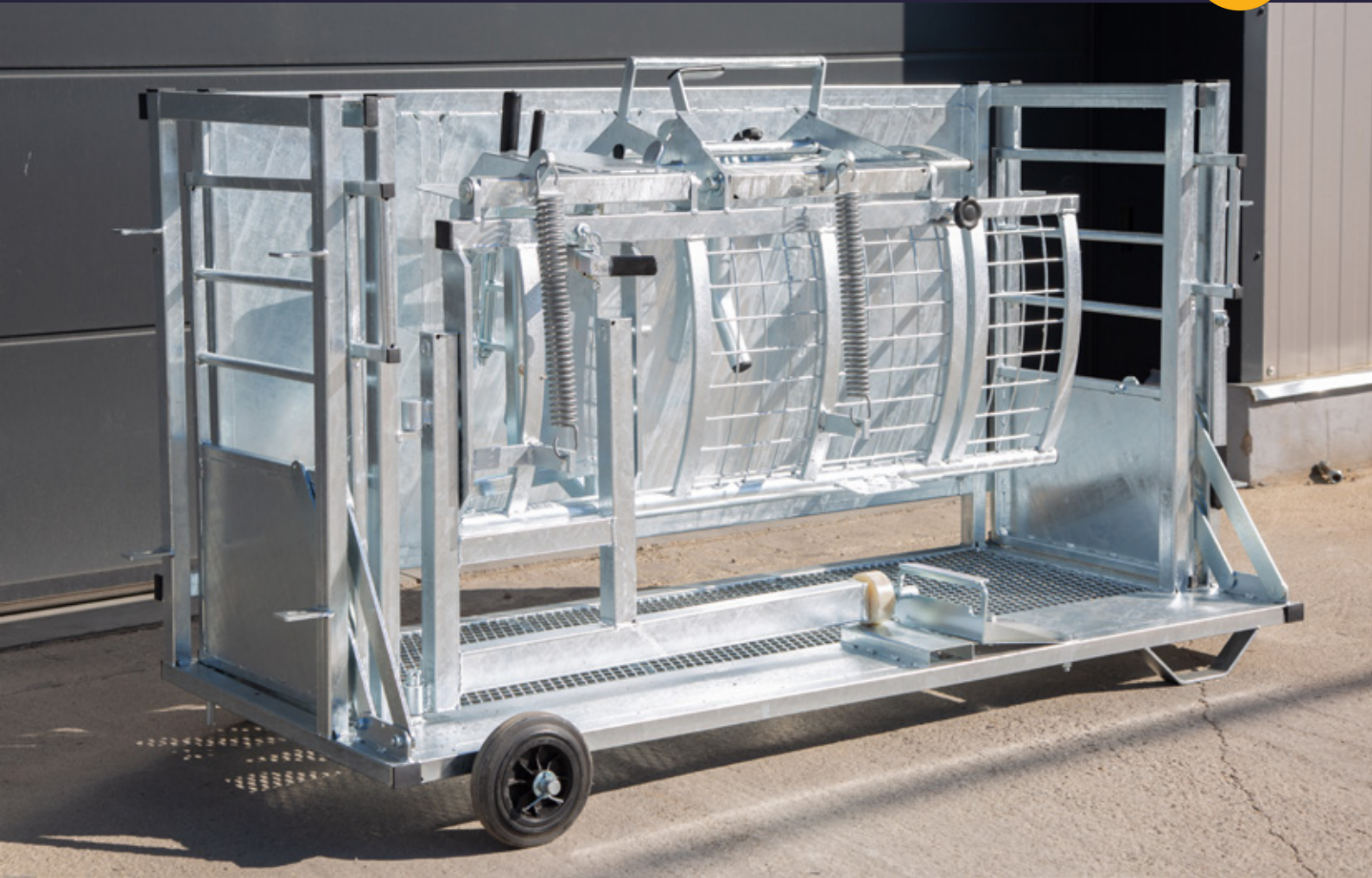

Stand de contentie pentru intretinerea ongloanelor

Standurile de contentie a ovinelor asigura animalul fara riscul de ranire, astfel incat acesta poate fi examinat si tratat.

- Design galvanizat la cald.



KM-JV-2-33 Stand de contentie pentru intretinerea ongloanelor cu jug





Cutie de miei pentru 2 oi mame langa perete | KM-JB-1-12F

Crese pentru miei, crese tip cutie (BOX)

Cresa de miei sau scoala de miei ofera oportunitatea de a separa animalele dupa fatare.

- Gardul de miel impiedica mama sa intre inapoi la miei.
- Design galvanizat la cald.



Panou cresa miel (L=1 m) | KM-JB-1-01

Crese de miei

KM-JB-1-01	Panou cresa miel (L=1 m)
KM-JB-1-02	Panou cresa miel (L=2 m)
KM-JB-1-03	Panou cresa miel (L=3 m)

Crese tip cutie (BOX)

KM-JB-1-11	Cutie de miei pentru 1 mama oaie
KM-JB-1-11F	Cutie de miei pentru 1 mama oaie langa perete
KM-JB-1-12	Cutie de miei pentru 2 oi mame
KM-JB-1-12F	Cutie de miei pentru 2 oi mame langa perete
KM-JB-1-12-L	Cutie de miei pentru 2 oi mame, placata
KM-JB-1-14	Cutie de miei pentru 2 oi mame



Vizitati site-ul nostru web pentru mai multe informatii!
kismet.ro



Structuri de cantarire pentru oi si porci (810 mm x 1730 mm) | KM-JM-1-01

Cantare

Cantarele noastre sunt produse in versiuni de 300 / 600 / 1500 kg cu acuratete de 100 / 200 / 500 g.

- Usile din fata si din spate sunt usor de deschis/inchis. Celule din otel aliat (optional celule rezistente la acizi).
- Design galvanizat la cald.



KM-JM-1-01	Structuri de cantarire pentru oi si porci (810 mm x 1730 mm)
KM-JM-1-02	Structuri de cantarire pentru oi si porci (1200 mm x 2400 mm)

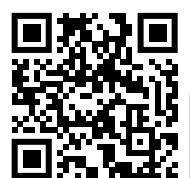
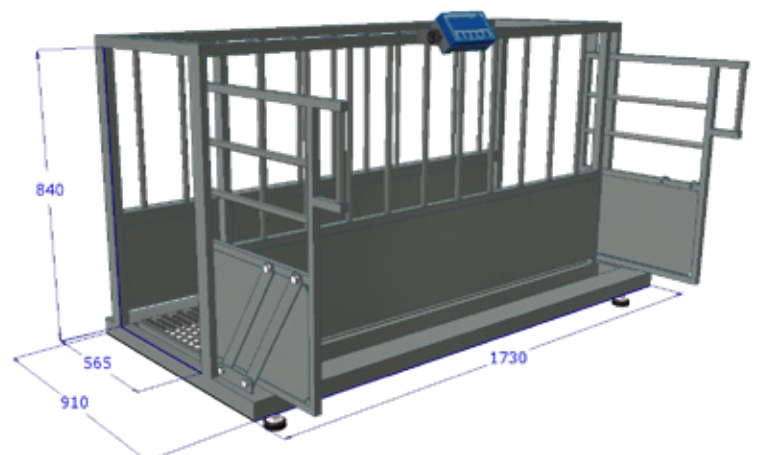



iesle pentru fan cu tava de colectare | KM-JE-3-22

Iesle rotunde pentru baloti

Din punct de vedere economic, este important sa nu risipim materiale de calitate.

- Ieslele de baloti rotunzi, ieslele cu gratii pentru fan si autoalimentatoarele ofera o oportunitate de a economisi furaj.
- Oferta noastra include si jgheaburi potrivite pentru hranirea si adaparea oilor.
- Design galvanizat la cald.



iesle pentru baloti rotunzi pentru oi cu acoperis (D=1800 mm) | KM-JE-3T-18

Iesle rotunde pentru baloti	
KM-JE-3-14	iesle baloti rotunzi pentru oi (D=1400 mm)
KM-JE-3-16	iesle baloti rotunzi pentru oi (D=1600 mm)
KM-JE-3-18	iesle baloti rotunzi pentru oi (D=1800 mm)
KM-JE-3T-14	iesle pentru baloti rotunzi pentru oi cu acoperis (D=1400 mm)
KM-JE-3T-16	iesle pentru baloti rotunzi pentru oi cu acoperis (D=1600 mm)
KM-JE-3T-18	iesle pentru baloti rotunzi pentru oi cu acoperis (D=1800 mm)
Iesle pentru fan	
KM-JE-3-20	iesle pentru fan (L=2 m)
KM-JE-3-22	iesle pentru fan cu tava de colectare (L=2 m)
KM-JE-3-24	iesle pentru fan cu tava larga pentru furaje si colectare (L=2 m)
Iesle cu auto-alimentare	
KM-JE-3-31	Hranitor dublu pentru oi cu rezervor (L=1 m, fara acoperis)
KM-JE-3-31WR	Hranitor dublu pentru oi cu rezervor (L=1 m, cu acoperis)
KM-JE-3-32	Hranitor dublu pentru oi cu rezervor (L=2 m, fara acoperis)
KM-JE-3-32WR	Hranitor dublu pentru oi cu rezervor (L=2 m, cu acoperis)
KM-JE-3-32OS	Hranitor pentru oi cu rezervor (L=2 m, fara acoperis)
KM-JE-3-32OSWR	Hranitor pentru oi cu rezervor (L=2 m, cu acoperis)
KM-JE-3-LSHH	Suport de sare





Jgheaburi	
KM-JE-3-420L	Jgheab de hranire pentru oi cu picioare din tabla (L=2 m)
KM-JE-3-420H	Jgheab pentru oi cu picioare de sprijin (L=2 m)
KM-JE-3-430L	Jgheab de hranire pentru oi cu picioare din tabla (L=3 m)
KM-JE-3-430H	Jgheab pentru oi cu picioare de sprijin (L=3 m)
KM-JE-3-5125L	Jgheab pentru oi cu picioare din tabla (L=1,25 m)
KM-JE-3-5125H	Jgheab pentru oi cu picioare de sprijin (L=1,25 m)
KM-JE-3-5200L	Jgheab pentru oi cu picioare din tabla (L=2 m)
KM-JE-3-5200H	Jgheab pentru oi cu picioare de sprijin (L=2 m)
KM-JE-3-5250L	Jgheab pentru oi cu picioare din tabla (L=2,5 m)
KM-JE-3-5250H	Jgheab pentru oi cu picioare de sprijin (L=2,5 m)
KM-JE-3-5375L	Jgheab pentru oi cu picioare din tabla (L=3,75 m)
KM-JE-3-5375H	Jgheab pentru oi cu picioare de sprijin (L=3,75 m)
KM-JE-3-5500H	Jgheab pentru oi cu picioare de sprijin (L=5 m)



Jgheab pentru oi cu picioare de sprijin
KM-JE-3-5200H

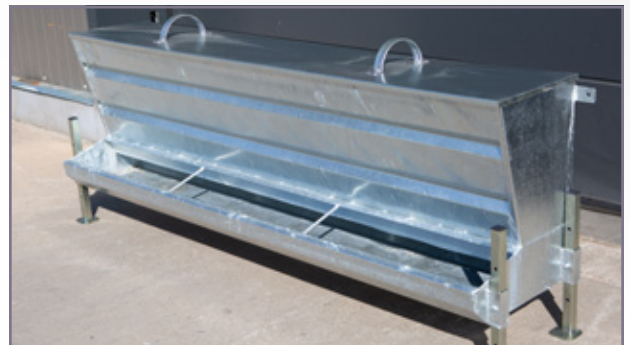

Hranitor pentru oi cu rezervor (L=2 m, cu acoperis)
KM-JE-3-32OSWR



Stand de muls oi

Stand de muls, realizat exclusiv la comanda in functie de nevoile individuale.

- Design galvanizat la cald.

KM-JF-1-02

Stand de
muls oi

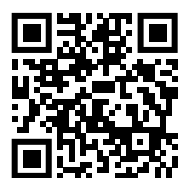

Consultati oferta pe site-ul nostru!
kismet.ro



Hangar cu laturi deschise 12 m x 30 m x 4 m | Locul constructiei: Dunaharaszti

Strucuri metalice deschise

Printre referintele noastre se gasesc si constructii de depozitare masini si culturi, alte cladiri agricole, hale industriale si structuri de spalatorie auto!

Ne asumam constructia completa a cladirilor de hale, de la planificare, pana la finalizarea procedurii de autorizare, pana la predarea la cheie!



Vizitati site-ul nostru web pentru mai multe informatii!
kismet.ro



Acoperire completa rampa logistica
66 m x 8,5 m x 4,5 m
Locul constructiei: **Szolnok**

Vizitati site-ul nostru web pentru mai multe informatii!



Magazie de masini deschisa 12 m x 26,5 m x 4,5 m | Locul constructiei: Szalmatercs





Depozitare masini si recolte 13 m x 24 m x 5 m | Locul constructiei: Detk

Hambare si garaje de depozitare inchise

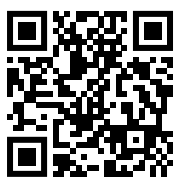

Consultati oferta pe site-ul nostru!
kismetal.ro



Magazie inchis pentru masini agricole
8 m x 22 m x 3,5 m
Locul constructiei: **Zagyvarékas**





Grajd bovine deschis cu sistem de selectie 20 m x 48 m x 4 m | Locul constructiei: Pusztaföldvár

Hambare si garaje de depozitare inchise



Consultati oferta pe site-ul nostru!
kismet.ro



Magazie de masini agricole partial deschis 8 m x 30 m x 3,5 m | Locul constructiei: Tiszaderzs

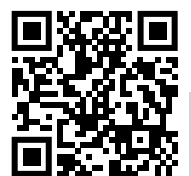



Hangar inchis 15 m x 20 m x 5 m | Locul constructiei: Kápolnásnyék

Hambare si garaje de depozitare inchise

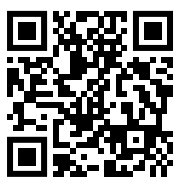

Consultati oferta pe site-ul nostru!
kismetal.ro



Depozit culturi 15 m x 52 m x 4,8 m | Locul constructiei: Almamellék

Hale de depozitare a recoltelor



Consultati oferta pe site-ul nostru!
kismet.ro





Depozit agricol 20 m x 48 m x 5 m | Locul constructiei: Szigetcsép

Hale de depozitare a recoltelor



Depozit agricol | Locul constructiei: Kecskemét



Consultati oferta pe site-ul nostru!
kismet.ro



Depozit agricol 24 m x 45 m x 5,3 m | Locul constructiei: **Visznek**



Hambar de cereale cu acoperis in fata | Locul constructiei: **Medgyesegyháza**

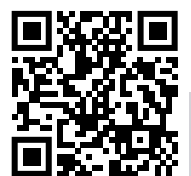



Restaurare birouri si sala atelier 12 m x 45 m x 4,5 m | Locul constructiei: Pécel

Hale din panouri sandwich

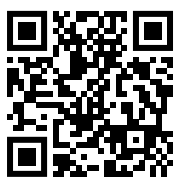

Consultati oferta pe site-ul nostru!
kismet.ro



Cladire spalatorie auto cu structura usoara cu 3 statii | Locul constructiei: Heves

Cladiri de spalatorie auto



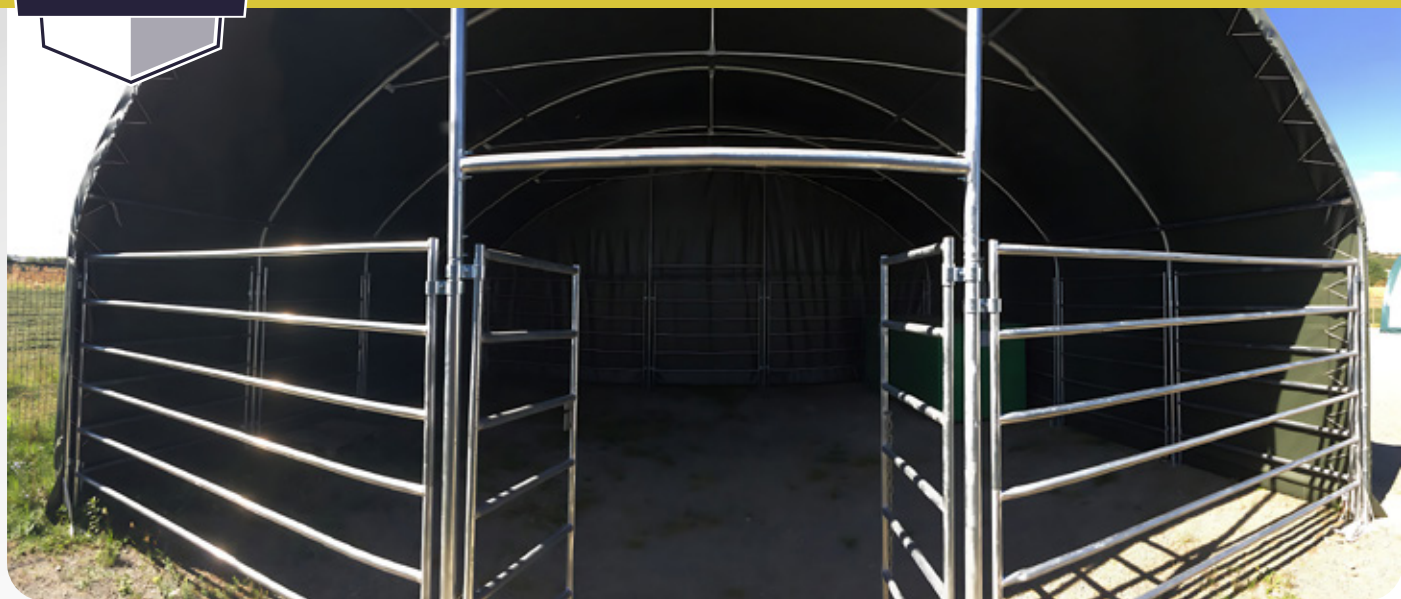

Corturi cu folosinta universala

Corturi realizate pe masura in functie de nevoile individuale.

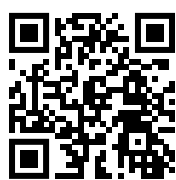

Consultati oferta pe site-ul nostru!
kismetal.ro



Corturi industriale tip casa		
Numarul articolului:	Dimensiuni (m):	Data:
KM-UTH-59	La.: 6,1 Lu.: 9,76 In.: 4,88	Suprafata de baza: 59 m ² prelata PVC: 750 g/m ² Teava dubla cu zabrele: 40 x 1,5 mm - 40 x 1,5 mm
KM-UTH-59-0	La.: 6,1 Lu.: 9,76 In.: 4,88	Suprafata de baza: 59 m ² prelata PVC: 750 g/m ² Teava dubla cu zabrele: 40 x 1,5 mm - 40 x 1,5 mm
KM-UTH-74	La.: 6,1 Lu.: 12,2 In.: 4,88	Suprafata de baza: 74 m ² prelata PVC: 750 g/m ² Teava dubla cu zabrele: 40 x 1,5 mm - 40 x 1,5 mm
KM-UTH-111	La.: 9,15 Lu.: 12,2 In.: 6,1	Suprafata de baza: 111 m ² prelata PVC: 750 g/m ² Teava dubla cu zabrele: 48 x 1,5 mm - 48 x 1,5 mm
KM-UTH-139	La.: 9,15 Lu.: 15,25 In.: 6,1	Suprafata de baza: 139 m ² prelata PVC: 750 g/m ² Teava dubla cu zabrele: 48 x 1,5 mm - 48 x 1,5 mm
KM-UTH-167	La.: 9,15 Lu.: 18,3 In.: 6,1	Suprafata de baza: 167 m ² prelata PVC: 750 g/m ² Teava dubla cu zabrele: 48 x 1,5 mm - 48 x 1,5 mm
KM-UTH-223	La.: 9,15 Lu.: 24,4 In.: 6,1	Suprafata de baza: 223 m ² prelata PVC: 750 g/m ² Teava dubla cu zabrele: 48 x 1,5 mm - 48 x 1,5 mm
KM-UTH-122	La.: 10 Lu.: 12,2 In.: 5,2	Suprafata de baza: 122 m ² prelata PVC: 750 g/m ² Teava dubla cu zabrele: 48 x 1,5 mm - 48 x 1,5 mm
KM-UTH-122_2	La.: 10 Lu.: 12,2 In.: 6,1	Suprafata de baza: 122 m ² prelata PVC: 750 g/m ² Teava dubla cu zabrele: 60 x 1,5 mm - 60 x 1,5 mm
KM-UTH-122-0	La.: 10 Lu.: 12,2 In.: 6,1	Suprafata de baza: 122 m ² prelata PVC: 750 g/m ² Teava dubla cu zabrele: 60 x 1,5 mm - 60 x 1,5 mm
KM-UTH-152	La.: 10 Lu.: 15,25 In.: 5,2	Suprafata de baza: 152 m ² prelata PVC: 750 g/m ² Teava dubla cu zabrele: 48 x 1,5 mm - 48 x 1,5 mm
KM-UTH-183	La.: 10 Lu.: 18,3 In.: 5,2	Suprafata de baza: 183 m ² prelata PVC: 750 g/m ² Teava dubla cu zabrele: 48 x 1,5 mm - 48 x 1,5 mm
KM-UTH-183_2	La.: 10 Lu.: 18,3 In.: 6,1	Suprafata de baza: 183 m ² prelata PVC: 750 g/m ² Teava dubla cu zabrele: 60 x 1,5 mm - 60 x 1,5 mm
KM-UTH-183-0	La.: 10 Lu.: 18,3 In.: 6,1	Suprafata de baza: 183 m ² prelata PVC: 750 g/m ² Teava dubla cu zabrele: 60 x 1,5 mm - 60 x 1,5 mm
KM-UTH-244	La.: 10 Lu.: 24,4 In.: 5,2	Suprafata de baza: 244 m ² prelata PVC: 750 g/m ² Teava dubla cu zabrele: 48 x 1,5 mm - 48 x 1,5 mm
KM-UTH-244_2	La.: 10 Lu.: 24,4 In.: 6,1	Suprafata de baza: 244 m ² prelata PVC: 750 g/m ² Teava dubla cu zabrele: 60 x 1,5 mm - 60 x 1,5 mm
KM-UTH-244-0	La.: 10 Lu.: 24,4 In.: 6,1	Suprafata de baza: 244 m ² prelata PVC: 750 g/m ² Teava dubla cu zabrele: 60 x 1,5 mm - 60 x 1,5 mm
KM-UTH-223_2	La.: 12,2 Lu.: 18,3 In.: 6,4	Suprafata de baza: 223 m ² prelata PVC: 750 g/m ² Teava dubla cu zabrele: 60 x 1,5 mm - 60 x 1,5 mm
KM-UTH-223_3	La.: 12,2 Lu.: 18,3 In.: 7	Suprafata de baza: 223 m ² prelata PVC: 750 g/m ² Teava dubla cu zabrele: 60 x 1,5 mm - 60 x 1,5 mm
KM-UTH-297	La.: 12,2 Lu.: 24,4 In.: 6,4	Suprafata de baza: 297 m ² prelata PVC: 750 g/m ² Teava dubla cu zabrele: 60 x 1,5 mm - 60 x 1,5 mm
KM-UTH-297_2	La.: 12,2 Lu.: 24,4 In.: 7	Suprafata de baza: 297 m ² prelata PVC: 750 g/m ² Teava dubla cu zabrele: 60 x 1,5 mm - 60 x 1,5 mm
KM-UTH-372	La.: 15,25 Lu.: 24,4 In.: 7	Suprafata de baza: 372 m ² prelata PVC: 900 g/m ² Teava dubla cu zabrele: 60 x 1,8 mm - 60 x 1,5 mm
KM-UTH-465	La.: 15,25 Lu.: 30,5 In.: 7	Suprafata de baza: 465 m ² prelata PVC: 900 g/m ² Teava dubla cu zabrele: 60 x 1,8 mm - 60 x 1,5 mm
KM-UTH-558	La.: 15,25 Lu.: 36,6 In.: 7	Suprafata de baza: 558 m ² prelata PVC: 900 g/m ² Teava dubla cu zabrele: 60 x 1,8 mm - 60 x 1,5 mm
KM-UTH-697	La.: 15,25 Lu.: 45,75 In.: 7	Suprafata de baza: 697 m ² prelata PVC: 900 g/m ² Teava dubla cu zabrele: 60 x 1,8 mm - 60 x 1,5 mm
KM-UTH-446	La.: 18,3 Lu.: 24,4 In.: 7,6	Suprafata de baza: 446 m ² prelata PVC: 900 g/m ² Teava dubla cu zabrele: 60 x 1,8 mm - 60 x 1,5 mm
KM-UTH-558_2	La.: 18,3 Lu.: 30,5 In.: 7,6	Suprafata de baza: 558 m ² prelata PVC: 900 g/m ² Teava dubla cu zabrele: 60 x 1,8 mm - 60 x 1,5 mm
KM-UTH-669	La.: 18,3 Lu.: 36,6 In.: 7,6	Suprafata de baza: 669 m ² prelata PVC: 900 g/m ² Teava dubla cu zabrele: 60 x 1,8 mm - 60 x 1,5 mm
KM-UTH-651	La.: 21,35 Lu.: 30,5 In.: 8,5	Suprafata de baza: 651 m ² prelata PVC: 900 g/m ² Teava dubla cu zabrele: 76 x 2 mm - 60 x 1,5 mm
KM-UTH-781	La.: 21,35 Lu.: 36,6 In.: 8,5	Suprafata de baza: 781 m ² prelata PVC: 900 g/m ² Teava dubla cu zabrele: 76 x 2 mm - 60 x 1,5 mm
KM-UTH-976	La.: 21,35 Lu.: 45,75 In.: 8,5	Suprafata de baza: 976 m ² prelata PVC: 900 g/m ² Teava dubla cu zabrele: 76 x 2 mm - 60 x 1,5 mm
KM-UTH-1302	La.: 21,35 Lu.: 61 In.: 8,5	Suprafata de baza: 1302 m ² prelata PVC: 900 g/m ² Teava dubla cu zabrele: 76 x 2 mm - 60 x 1,5 mm

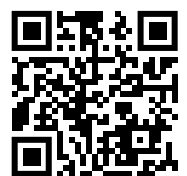

Corturi semicirculare

Numarul articolului:	Dimensiuni (m):	Comentariu:	Data:
KM-UTR-37_Z	La.: 6,1 Lu.: 6,1 In.: 3,66	cu fermoar	Suprafata de baza: 37 m ² prelata PVC: 650 g/m ² Teava simpla: 70 x 42 x 1,5 - 42 x 1,2 mm
KM-UTR-37_D	La.: 6,1 Lu.: 6,1 In.: 3,66	cu usa	Suprafata de baza: 37 m ² prelata PVC: 650 g/m ² Teava simpla: 70 x 42 x 1,5 - 42 x 1,2 mm
KM-UTR-55_Z	La.: 6,1 Lu.: 9,15 In.: 3,66	cu fermoar	Suprafata de baza: 55 m ² prelata PVC: 650 g/m ² Teava simpla: 70 x 42 x 1,5 - 42 x 1,2 mm
KM-UTR-55_D	La.: 6,1 Lu.: 9,15 In.: 3,66	cu usa	Suprafata de baza: 55 m ² prelata PVC: 650 g/m ² Teava simpla: 70 x 42 x 1,5 - 42 x 1,2 mm
KM-UTR-78_Z	La.: 6,1 Lu.: 12,8 In.: 3,66	cu fermoar	Suprafata de baza: 78 m ² prelata PVC: 650 g/m ² Teava simpla: 70 x 42 x 1,5 - 42 x 1,2 mm
KM-UTR-78_D	La.: 6,1 Lu.: 12,8 In.: 3,66	cu usa	Suprafata de baza: 78 m ² prelata PVC: 650 g/m ² Teava simpla: 70 x 42 x 1,5 - 42 x 1,2 mm
KM-UTR-109	La.: 9,15 Lu.: 12 In.: 4,5		Suprafata de baza: 109 m ² prelata PVC: 750 g/m ² Teava simpla: 70 x 42 x 2 - 40 x 1,5 mm
KM-UTR-146	La.: 9,15 Lu.: 16 In.: 4,5		Suprafata de baza: 146 m ² prelata PVC: 750 g/m ² Teava simpla: 70 x 42 x 2 - 40 x 1,5 mm
KM-UTR-183	La.: 9,15 Lu.: 20 In.: 4,5		Suprafata de baza: 183 m ² prelata PVC: 750 g/m ² Teava simpla: 70 x 42 x 2 - 40 x 1,5 mm
KM-UTR-237	La.: 9,15 Lu.: 26 In.: 4,5		Suprafata de baza: 237 m ² prelata PVC: 750 g/m ² Teava simpla: 70 x 42 x 2 - 40 x 1,5 mm
KM-UTR-146_2	La.: 12,2 Lu.: 12 In.: 6,1		Suprafata de baza: 146 m ² prelata PVC: 750 g/m ² Teava simpla: 86 x 56 x 2 - 48 x 1,5 mm
KM-UTR-219	La.: 12,2 Lu.: 18 In.: 6,1		Suprafata de baza: 219 m ² prelata PVC: 750 g/m ² Teava simpla: 86 x 56 x 2 - 48 x 1,5 mm
KM-UTR-297_WOF	La.: 12,2 Lu.: 24,4 In.: 6,1	fara capete	Suprafata de baza: 297 m ² prelata PVC: 750 g/m ² Teava simpla: 86 x 56 x 2 - 48 x 1,5 mm
KM-UTR-297	La.: 12,2 Lu.: 24,4 In.: 6,1		Suprafata de baza: 297 m ² prelata PVC: 750 g/m ² Teava simpla: 86 x 56 x 2 - 48 x 1,5 mm
KM-UTR-366	La.: 12,2 Lu.: 30 In.: 6,1		Suprafata de baza: 366 m ² prelata PVC: 750 g/m ² Teava simpla: 86 x 56 x 2 - 48 x 1,5 mm

Corturi pentru animale

Numarul articolului:	Dimensiuni (m):	Data:
KM-LST-16	La.: 4 Lu.: 4 In.: 3,15	Suprafata de baza: 16 m ² prelata PVC: 750 g/m ² Teava simpla: 60 x 1,8 - 60 x 1,5 mm Greutate: 550 kg
KM-LST-36	La.: 6 Lu.: 6 In.: 3,7	Suprafata de baza: 36 m ² prelata PVC: 750 g/m ² Teava simpla: 60 x 1,8 - 60 x 1,5 mm Greutate: 700 kg
KM-LST-64	La.: 8 Lu.: 8 In.: 4	Suprafata de baza: 64 m ² prelata PVC: 750 g/m ² Teava simpla: 60 x 1,8 - 60 x 1,5 mm Greutate: 990 kg
KM-LST-100	La.: 10 Lu.: 10 In.: 4,5	Suprafata de baza: 100 m ² prelata PVC: 900 g/m ² Teava cu zabrele: 60 x 1,8 - 60 x 1,5 mm Greutate: 1680 kg
KM-LST-144	La.: 12 Lu.: 12 In.: 5	Suprafata de baza: 144 m ² prelata PVC: 900 g/m ² Teava cu zabrele: 60 x 1,8 - 60 x 1,5 mm Greutate: 2250 kg





Corturi tip depozitare cu structura din aluminiu

Numarul articolului:	Dimensiuni (m):	Data:
KM-UAST-90	La.: 6 Lu.: 15 In.: 4 / 5,2	Suprafata de baza: 90 m ² prelata PVC acopersi / lateral: 850 / 650 g/m ² Structura: 166 x 88 x 3 mm
KM-UAST-150	La.: 10 Lu.: 15 In.: 4 / 5,8	Suprafata de baza: 150 m ² prelata PVC acopersi / lateral: 850 / 650 g/m ² Structura: 166 x 88 x 3 mm
KM-UAST-200	La.: 10 Lu.: 20 In.: 4 / 5,8	Suprafata de baza: 200 m ² prelata PVC acopersi / lateral: 850 / 650 g/m ² Structura: 166 x 88 x 3 mm
KM-UAST-480	La.: 12 Lu.: 40 In.: 4 / 6,5	Suprafata de baza: 480 m ² prelata PVC acopersi / lateral: 850 / 650 g/m ² Structura: 166 x 88 x 3 mm
KM-UAST-300	La.: 15 Lu.: 20 In.: 4 / 6,5	Suprafata de baza: 300 m ² prelata PVC acopersi / lateral: 850 / 650 g/m ² Structura: 166 x 88 x 3 mm
KM-UAST-375	La.: 15 Lu.: 25 In.: 4 / 6,5	Suprafata de baza: 375 m ² prelata PVC acopersi / lateral: 850 / 650 g/m ² Structura: 166 x 88 x 3 mm
KM-UAST-450	La.: 15 Lu.: 30 In.: 4 / 6,5	Suprafata de baza: 450 m ² prelata PVC acopersi / lateral: 850 / 650 g/m ² Structura: 166 x 88 x 3 mm
KM-UAST-600	La.: 15 Lu.: 40 In.: 4 / 6,5	Suprafata de baza: 600 m ² prelata PVC acopersi / lateral: 850 / 650 g/m ² Structura: 166 x 88 x 3 mm
KM-UAST-750	La.: 15 Lu.: 50 In.: 4 / 6,5	Suprafata de baza: 750 m ² prelata PVC acopersi / lateral: 850 / 650 g/m ² Structura: 166 x 88 x 3 mm

Corturi tip evenimente cu structura din aluminiu

Numarul articolului:	Dimensiuni (m):	Data:
KM-UAET-9	La.: 3 Lu.: 3 In.: 2,5 / 4,2	Suprafata de baza: 9 m ² prelata PVC : 850 g/m ² Structura: 65 x 65 x 2,5 mm
KM-UAET-16	La.: 4 Lu.: 4 In.: 2,5 / 4,7	Suprafata de baza: 16 m ² prelata PVC: 850 g/m ² Structura: 65 x 65 x 2,5 mm
KM-UAET-25	La.: 5 Lu.: 5 In.: 2,5 / 5,2	Suprafata de baza: 25 m ² prelata PVC: 850 g/m ² Structura: 65 x 65 x 2,5 mm
KM-UAET-36	La.: 6 Lu.: 6 In.: 2,5 / 5,8	Suprafata de baza: 36 m ² prelata PVC: 850 g/m ² Structura: 65 x 65 x 2,5 mm
KM-UAET-54	La.: 6 Lu.: 9 In.: 2,5 / 3,6	Suprafata de baza: 54 m ² prelata PVC: 850 g/m ² Structura: 84 x 48 x 3 mm
KM-UAET-72	La.: 6 Lu.: 12 In.: 2,5 / 3,6	Suprafata de baza: 72 m ² prelata PVC: 850 g/m ² Structura: 84 x 48 x 3 mm
KM-UAET-90	La.: 6 Lu.: 15 In.: 2,5 / 3,6	Suprafata de baza: 90 m ² prelata PVC: 850 g/m ² Structura: 84 x 48 x 3 mm
KM-UAET-150	La.: 10 Lu.: 15 In.: 2,5 / 4,5	Suprafata de baza: 150 m ² prelata PVC: 850 g/m ² Structura: 122 x 68 x 3 mm
KM-UAET-200	La.: 10 Lu.: 20 In.: 2,5 / 4,5	Suprafata de baza: 200 m ² prelata PVC: 850 g/m ² Structura: 122 x 68 x 3 mm
KM-UAET-250	La.: 10 Lu.: 25 In.: 2,5 / 4,5	Suprafata de baza: 250 m ² prelata PVC: 850 g/m ² Structura: 122 x 68 x 3 mm
KM-UAET-300	La.: 10 Lu.: 30 In.: 2,5 / 4,5	Suprafata de baza: 300 m ² prelata PVC: 850 g/m ² Structura: 122 x 68 x 3 mm
KM-UAET-375	La.: 15 Lu.: 25 In.: 3,5 / 5,5	Suprafata de baza: 375 m ² prelata PVC: 850 g/m ² Structura: 122 x 68 x 3 mm
KM-UAET-375_2	La.: 15 Lu.: 25 In.: 4 / 6,5	Suprafata de baza: 375 m ² prelata PVC: 850 g/m ² Structura: 166 x 88 x 3 mm
KM-UAET-450	La.: 15 Lu.: 30 In.: 4 / 6,5	Suprafata de baza: 450 m ² prelata PVC: 850 g/m ² Structura: 166 x 88 x 3 mm
KM-UAET-10_HEX	La.: 3 Lu.: 3 In.: 2,5 / 3,7	Hexagon, Suprafata de baza: 10 m ² prelata PVC: 850 g/m ² Structura: 84 x 48 x 3 mm





Sisteme de rafturi din otel pentru depozitare



Numarul articolului:	Dimensiuni (mm):	Nume:	Data:
KM-STSHSY-ST-01	Ad.: 600 Lu.: 2000 In.: 2000	Sistem de rafturi din otel pentru depozitare	4 bucati de rafturi, 2 picioare
KM-STSHSY-ST_AL	In.: 2000	1 picior aditional	Capacitate: 0,2 tone
KM-STSHSY-ST_AS	Lu.: 2000	1 raft aditional	Capacitate: 0,1 tone



Vizitati site-ul nostru web pentru mai multe informatii!
kismet.ro



Sisteme de rafturi din otel pentru depozitarea paletilor

Numarul articolului:	Dimensiuni (mm):	Nume:	Data:
KM-STSHSY-03-2	Ad.: 1000 Lu.: 5400 In.: 3000	Sistem de rafturi din otel format din doua piese (3 m)	12 bucati de conectori, 3 picioare
KM-STSHSY-03-3	Ad.: 1000 Lu.: 8100 In.: 3000	Sistem de rafturi din otel format din trei piese (3 m)	18 bucati de conectori, 4 picioare
KM-STSHSY-035-2	Ad.: 1000 Lu.: 5400 In.: 3500	Sistem de rafturi din otel format din doua piese (3,5 m)	12 bucati de conectori, 3 picioare
KM-STSHSY-035-3	Ad.: 1000 Lu.: 8100 In.: 3500	Sistem de rafturi din otel format din trei piese (3,5 m)	18 bucati de conectori, 4 picioare
KM-STSHSY-04-2	Ad.: 1000 Lu.: 5400 In.: 4000	Sistem de rafturi din otel format din doua piese (4 m)	12 bucati de conectori, 3 picioare
KM-STSHSY-04-3	Ad.: 1000 Lu.: 8100 In.: 4000	Sistem de rafturi din otel format din trei piese (4 m)	18 bucati de conectori, 4 picioare
KM-STSHSY-06-2	Ad.: 1000 Lu.: 5400 In.: 6000	Sistem de rafturi din otel format din doua piese (6 m)	12 bucati de conectori, 3 picioare
KM-STSHSY-06-3	Ad.: 1000 Lu.: 8100 In.: 6000	Sistem de rafturi din otel format din trei piese (6 m)	18 bucati de conectori, 4 picioare
KM-STSHSY-03_AL	In.: 3000	1 picior aditional (3 m)	Capacitate: 3 tone
KM-STSHSY-035_AL	In.: 3500	1 picior aditional (3,5 m)	Capacitate: 3 tone
KM-STSHSY-04_AL	In.: 4000	1 picior aditional (4 m)	Capacitate: 3 tone
KM-STSHSY-06_AL	In.: 6000	1 picior aditional (6 m)	Capacitate: 3 tone
KM-STSHSY_AC	In.: 2700	1 conector aditional	Capacitate: 1,5 tone
KM-STSHSY_AMP	In.: 2700	1 platforma metalica aditional	Capacitate: 3 tone





KisMetál Kft.

Strada Hermann Oberth 1a, Sibiu 557260, Romania

E-mail: info@kismetal.ro

Tel: +40 752 122 366 (Romana, English)

+36 20 362 3112 (Maghiara, English)

kismetal.ro

corturikismetal.ro

crestereabovinelor.ro



facebook.com/kismetalro



youtube.com/@KismetalHu